

## Quick Start Guide

Easy steps to getting started

### 1 **Unpack Contents**

Unpack your digitizer package and check for major components.

1. Medi-2200 Plus Digitizer
2. Power Adapter
3. Power Cord
4. Film Alignment Ruler
5. Hi-Speed USB Cable
6. Software CD
7. Intraoral X-Ray Film Holder
8. Panoramic X-Ray Film Holder
9. Cephalometric X-Ray Film Holder

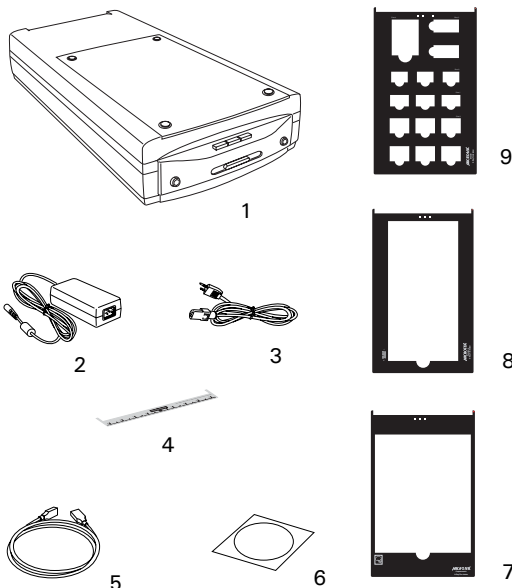

### 2 **Install Software**

**Important:** You must install software before connecting your digitizer. Always close any open programs and turn off Anti-virus utilities before installing software.

- A. Turn on your computer.
- B. Place the **Medi-2200 Plus CD-ROM** into the CD-ROM drive, and follow the on-screen instructions to install the driver and software.
- C. Restart your computer.

**NOTE:** If the Software Installer screen does not come up automatically, double-click the following in succession: "My Computer"; the CD-ROM icon; then cdsetup.exe to start the installer program.

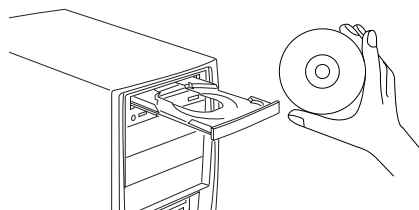

## 3 Unlock Digitizer

- A. Remove the yellow “Unlock” stickers from your digitizer.
- B. With the digitizer power off, tilt the back left corner of the digitizer to see the locking switch at the bottom. Do not turn the digitizer upside down when attempting to unlock, as this may damage the digitizer’s mechanism.
- C. Push the locking switch to the position (as indicated by the graphic on the right), with the icon on the lock showing as “unlocked”.
- D. Raise the digitizer lid (TMA), and look for the locking switch at the base of the TMA.
- E. Push the locking switch to the position (as indicated by the graphic on the right), with the icon on the lock showing as “unlocked”.

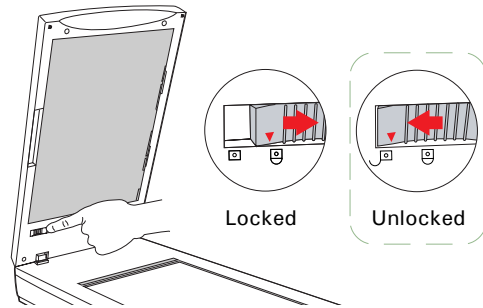
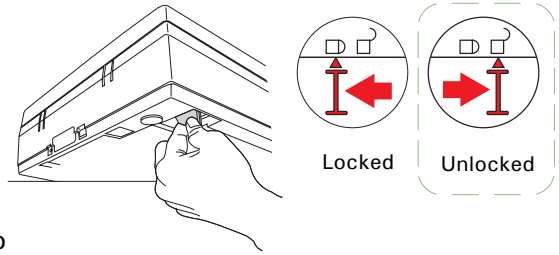

**NOTE:** To lock the digitizer and the TMA (for shipping and other purposes), turn the locking switch to the “Locked” position.

## 4 Connect Digitizer

### To the digitizer lid

Make sure the digitizer lid (TMA) is properly installed, with its connector securely connected to the scanner’s 15-pin accessory port.

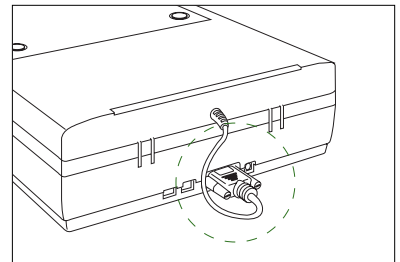

### To the power adapter

- A. Connect the power adapter to the back of the digitizer.
- B. Plug one end of the power cord into the power adapter, and plug the other end of the power cord into a wall outlet or other power source.

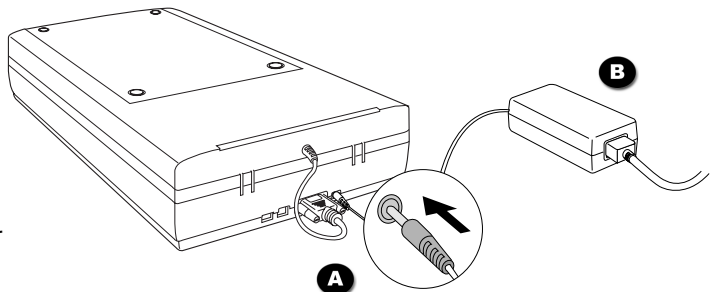

## Step 4: Connect Digitizer (cont.)

### To the Hi-Speed USB cable

- C. Connect one end of the Hi-Speed USB cable to your computer.
- D. Connect the other end of the Hi-Speed cable to the digitizer's USB port.

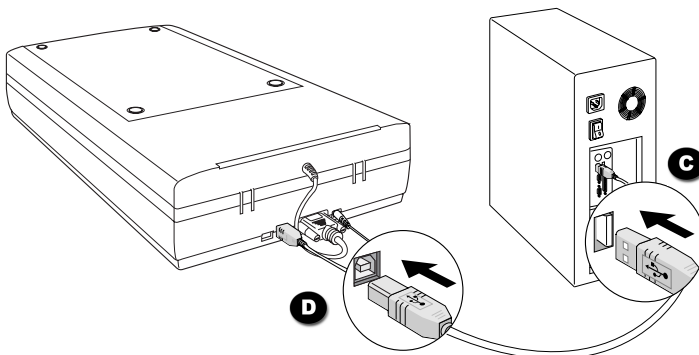



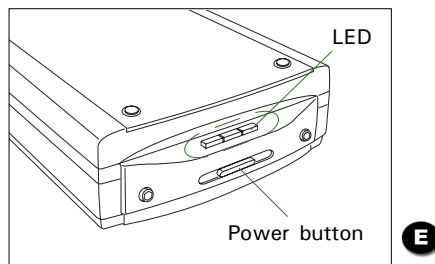

- E. Press the Power button on the front panel of the digitizer to turn the digitizer on; the LED will light up.
- The system will detect your digitizer automatically.

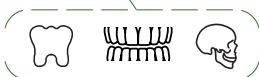
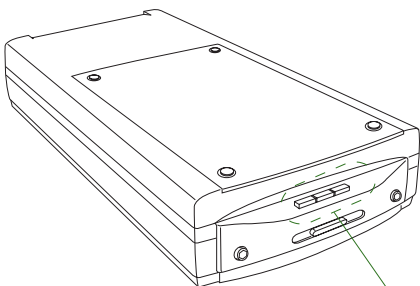

## Smart-Scan Buttons

The Medi-2200 Plus is equipped with three **Smart-Scan** buttons on the front panel of the digitizer, providing an intuition way to scan most common types of the dental film. These buttons are **Intraoral**, **Panoramic**, and **Cephalometric**.



- To scan intraoral dental film, press the  button.
- To scan panoramic film, press the  button.
- To scan cephalometric film, press the  button.

When the button is pressed, the digitizer will automatically detect the film holder used, crop the image to fit the scan frame, and perform the final scan at one time.

## Position Dental Film

To scan dental film, use the film holder included with your digitizer package, and match it with the correct type of dental film, such as intraoral dental film (size 0, 1, 2, 3, and 4), panoramic dental film or cephalometric dental film.

Using the film holder ensures precise alignment of film to yield consistent scans, and aids in the correct performance of the automatic cropping feature during film scanning. When you place the film holder, please take note of the followings:

- Align the film holder (with the side of the U-shaped edge) firmly against the top edge of the glass surface. Make sure to orient the side with the "Microtek" logo facing up.
- The red arrow marks on both the film holder and the digitizer are pointing to each other.
- Keep the Calibration window on the glass surface clear and unobstructed.

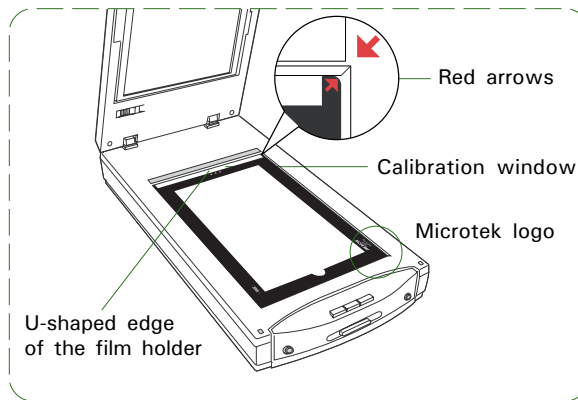

## To place dental film

- For panoramic film, use the Panoramic X-Ray Film Holder (Figure 1).
- For cephalometric film, use the Cephalometric X-Ray Film Holder (Figure 2).
- For intraoral dental film, use the Intraoral X-Ray Film Holder (Figure 3).

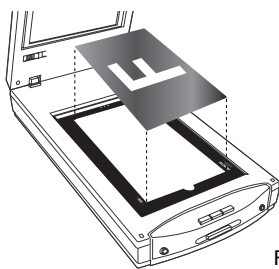

Figure 1

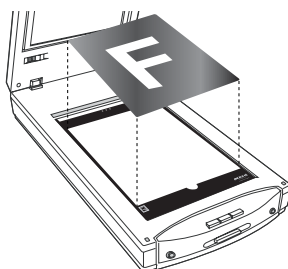

Figure 2

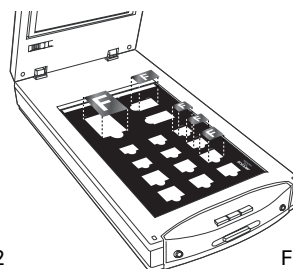
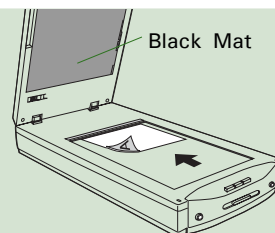

Figure 3

## Position Reflective Originals (e.g., documents or prints)

Place the reflective to be scanned facing down on the scan bed, with the top end of the reflective facing toward the back of the digitizer. Make sure that the Black Mat is installed on the digitizer lid (TMA).



## Scanning Basics

Before performing the dental film scanning, remove the **Black Mat** first.

Raise the digitizer lid (TMA), and push the Black Mat to the side to remove it from the digitizer lid (TMA).

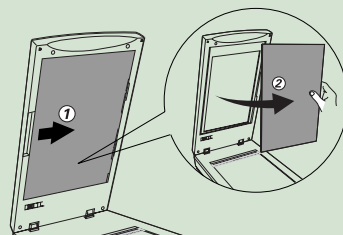

### 1. Place film holder and dental film

Follow the section of the "Position Dental Film" in this guide to place the film holder and film on the scan bed.

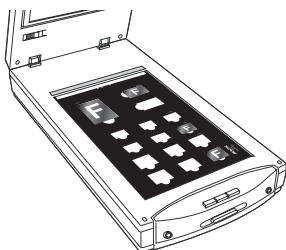

### 2. Launch ScanWizard Medi

To launch ScanWizard Medi as a stand-alone program, double-click the **ScanWizard Medi** icon on your desktop.

All four windows (Preview, Settings, Scan Job Queue and Information) appear automatically after the ScanWizard Medi is started up at the first time. You may hide the Scan Job Queue and Information windows from the View menu.



### 3. Specify scanning requirements

- a) In the Preview window, choose "X-Ray" from the **Scan Material** menu.



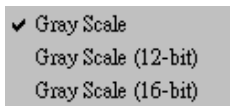

- b) In the Settings window, select the appropriate image output type (e.g., Gray Scale) in the **Type** drop-down menu.

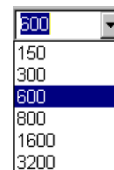

- c) In the Settings window, select a desired image output resolution (e.g., 300) in the **Resolution** drop-down menu.



### 4. Scan dental film

- a) Click the **Smart-Scan** button on the Preview window in the ScanWizard Medi or the button ( , , or  ) on the digitizer unit.
- b) When the "Scan To: Save As" dialog box appears (shown on next page), specify the folder location, a file name, and the format for the output image, then click Save. The image is scanned and saved to the specified location.

### Send image to application after saving:

If this option is checked, the scanned image is saved first and then automatically delivered to an application software as indicated in the destination box.

To view the scanned image, double-click the “Msmart Images” icon on the desktop, or retrieve it from the folder you assigned in the “Scan To: Save As” dialog box.

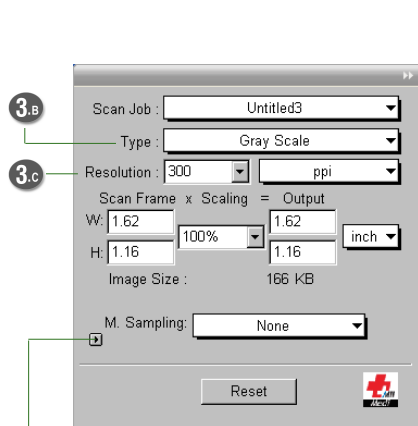
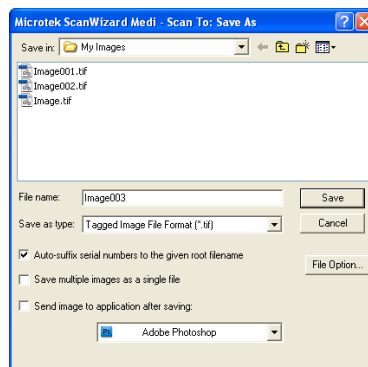

Settings Window

Window Expansion button  
(Click here to reveal the half bottom of the Settings window if you need to make further image adjustment.)

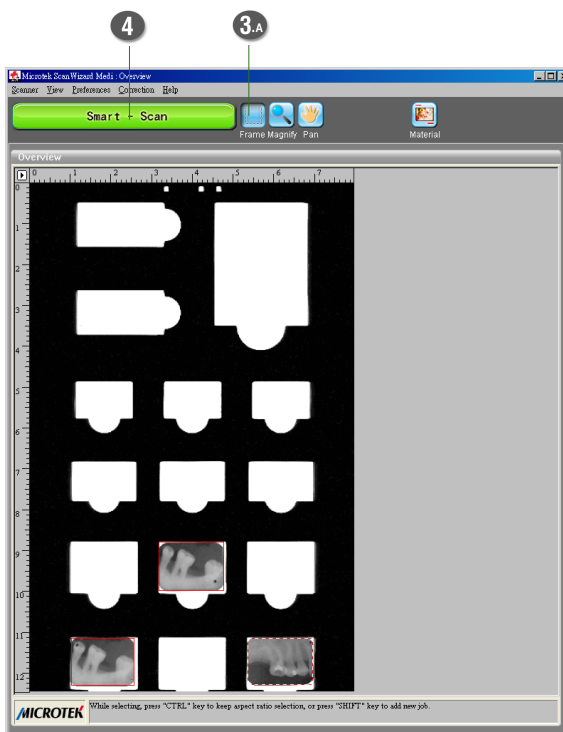

Preview Window

### Scanning Reflective Originals (e.g., documents or prints)

Follow the section of the “Position Reflective Originals” to place the reflective on the scan bed, then follow the procedures (steps 2 through 4) outlined in the “Scanning Basics” section to start your reflective scan.

In step 3a, instead, choose “Reflective” to switch to the Reflective scanning mode; a different look of the Preview window appears. For more details about how to scan the reflectives, refer to the Medi-2200 Plus User’s Manual.

## Problems?

The LED on the button panel indicate the status of the digitizer.



**On** - Ready to scan



**Flashing** - Scanning



**Off** - Digitizer is off or sleeping

**First, make sure that you have followed installation steps as described in this guide. Then if your problem is listed here, try the suggested solution.**

**1. No light comes on when the digitizer is turned on.**

Make sure your digitizer is connected to your computer and plugged into a power source.

**2. The Add/Remove Hardware Wizard appears on your screen.**

Click the "Cancel" button and close the ScanWizard Medi software.

Disconnect the Hi-Speed USB cable from the back of your computer, and refer to the installation instructions in this guide.

**3. When trying to scan, an error message appears on your screen that reads, "Can't Find Scanners".**

Make sure your digitizer is unlocked (see Step 3).

Make sure your digitizer is connected to your computer and plugged in to a power source (see Step 4).

Uninstall and reinstall the ScanWizard Medi software.

**4. After clicking scan, a blank screen appears.**

Make sure your digitizer is unlocked (see Step 3).

Uninstall and reinstall the ScanWizard Medi software.

**5. Having trouble scanning X-ray films.**

Make sure the TMA (Transparency Media Adapter) is properly installed, with its connector securely connected to the digitizer's 15-pin accessory port.

Make sure you place the film holder and film properly on the scan bed. Do not block the calibration window (as indicated in the "Position Dental Film" section).

Make sure you are in the "X-Ray" scanning mode. If not, click the "Scan Material" icon in the Preview window; then, select "X-Ray" as your scanning mode.

Uninstall and reinstall the ScanWizard Medi software.

**6. Having trouble scanning reflective originals.**

Make sure you place the reflective original to be scanned properly on the scan bed.

Make sure you are in the "Reflective" scanning mode. If not, click the "Scan Material" icon in the Preview window; then, select "Reflective" as your scanning mode.

Uninstall and reinstall the ScanWizard Medi software.

## Do You Need Assistance?

### Manuals

If you have additional questions and need further instruction or information, we provide electronic manuals for:

1. Using your Medi-2200 Plus
2. Using the ScanWizard Medi scanning software

To access the electronic manuals: Insert the Medi-2200 Plus CD-ROM into your computer's CD-ROM drive. Next, locate and click the "Manuals" option when the software installer window appears on your screen. Finally, select and click the title of the manual you wish to view.

### Missing Items

If your package is missing items, please call the Microtek Customer Service Department.

### Drivers & Software Upgrades

After you finish the installation of software, if you found that the installed drivers and software cannot run your product or your computer system properly later, please go to the Microtek **Download Service** site at [ww7.microtek.com.tw/service.php](http://ww7.microtek.com.tw/service.php) to download and install any updates you may require.

For additional information about Microtek products, please visit our website at [www.microtek.com](http://www.microtek.com).

#### Power Adapter

Use only power supplies (AC/DC adapters) listed below:

Voltage	Manufacturer	Model No.
100V to 240V	MAGIC POWER TECHNOLOGY CO., LTD	MPM-X50-15

**NOTE:** Please make sure that the electrical outlet to where the scanner will be connected is nearby and readily accessible.



Microtek International, Inc.  
No. 6, Industry East Road 3,  
Science-Based Industrial Park,  
Hsinchu 30077, Taiwan



EVESTAR GmbH  
Linsellesstraße 127-129  
D-47877 Willich, Germany

Copyright © 2013 Microtek International, Inc. The following are trademarks or registered trademarks of their respective companies: Microtek, ScanMaker, ScanWizard, Medi logo of Microtek International, Inc. All other trademarks or registered trademarks are the property of their respective holders. Specifications, software and hardware bundles are subject to change without notice. Delivery of technical support services subject to change without notice. Not responsible for typographical errors.

# MICROTEK