

Thermaltake Air Cooler UX 100

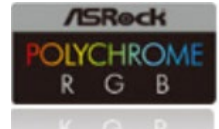

UX 100

ARGB Lighting CPU Cooler



Specification

Unit :mm

P/N	CL-P064-AL12SW-A
Compatibility (CPU Socket)	Intel LGA 1156/1155/1151/1150/775 AMD AM4/FM2/FM1/AM3+/AM3/AM2+/AM2
Dimension	122.3 x 122.3 x 66.1 mm(L x W x H)
Heatsink Material	Aluminum Fins
Fan Dimension	120 x 120 x 25 mm(L x W x H)
Fan Quantity	1pcs
Fan Speed	1800 RPM
Rated Voltage	12V
Start Voltage	6.0 V
Rated Current	0.52 A
Power Input	6.24 W
Air Flow	38.82 CFM
Air Pressure	1.48 mm-H ₂ O
Acoustical Noise.	26.92 dBA
Life Time	30,000 hours
Pin Connect	5V RGB header 2510 - 3Pin
Cooling Power	65 W



UX 100

Features

ARGB Lighting CPU Cooler

- Support MB RGB LED 5V sync, ASUS, GIGABYTE, MSI and ASROCK
- Build-In ARGB LEDs offer best lighting effect
- support up to 65W
- 120mm Quiet-Fan
- With 15 LED lighting
- 9 high Air Flow blade design for high cooling performance
- Long life hydraulic bearing for reliable and silent operation
- Universal Intel/ AMD socket compatibility

Dimension

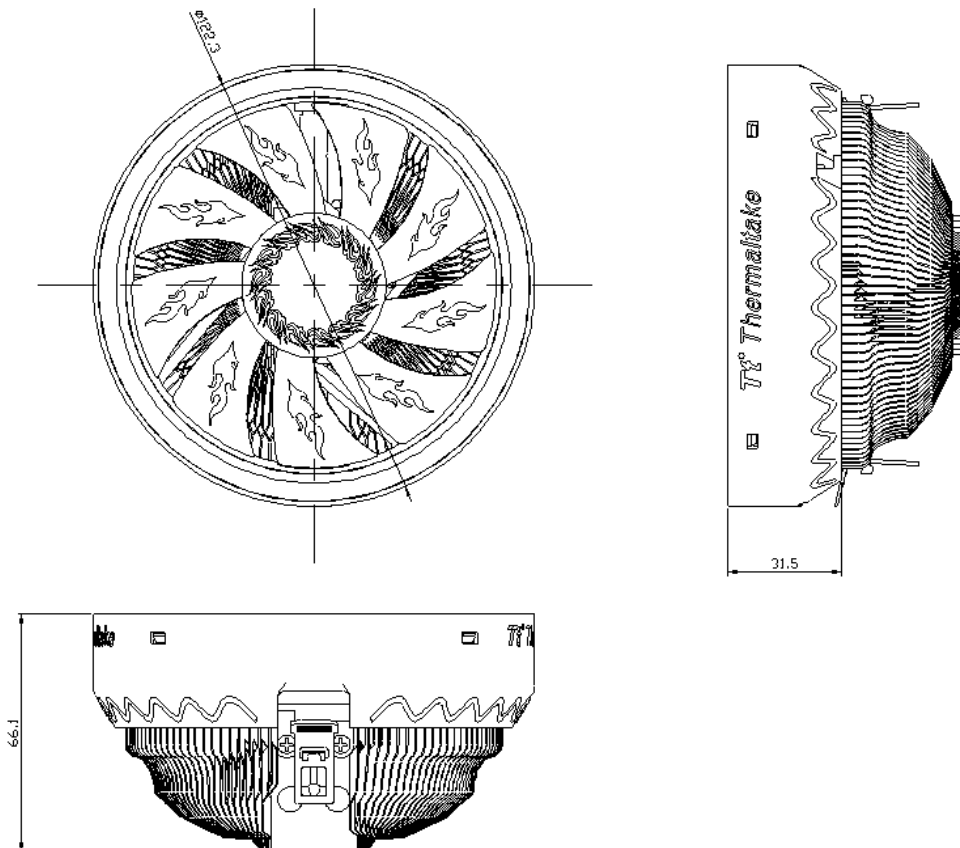

Thermaltake Air Cooler UX 100

Pictures



Top view



Bottom view



Side view



Universal Intel/ AMD socket



application

Sync 5V ARGB

Support ASUS □ MSI □ GIGABYTE and ASROCK 5V RGB motherboard Sync.

***Caution: the motherboard signal connector only supports 5V header.**



Aura Addressable Header



JRAINBOW Header



Addressable RGB LED Header



Digital Pin Header

MB SYNC

ASUS
Aura Addressable Strip Header(s)

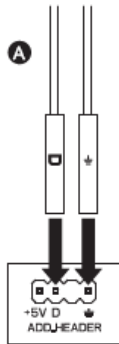

MSI
JRGB-strip Header(S)

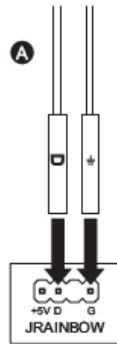

ASROCK
Addressable RGB LED Header(s)

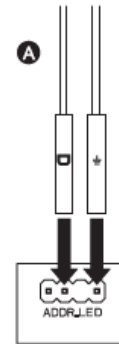

GIGABYTE
AOURS RGB Fusion with Digital LEDs

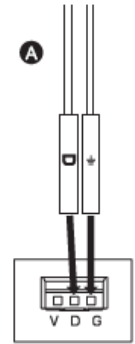

CAUTION

Please power off the PC and check the Positive and Negative ends on the connector before connecting the cable to mainboard. Connecting the wrong end can damage the fans.

Limited height DRAM

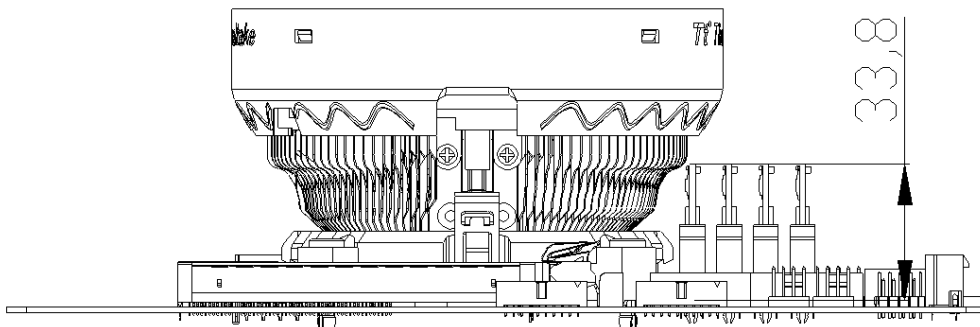

***Caution □ Only support shorter than 33.8 mm DRAM**

Thermaltake Air Cooler UX 100



UX 100

ARGB Lighting CPU Cooler

