

# Thermaltake H550 TG ARGB Middle tower

- **Style : Simple**
- **Size : Middle tower support up to ATX MB**
- **Material : Steel & Aluminum & Tempered Glass**
- **Main Feature**

- **Connection : Top-Front I/O ports with 1 x USB 3.0**
- **Ventilation : 1 preinstalled 120mm ARGB fans**
- **Support : Advance Cable Management**

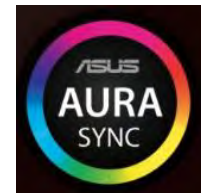

# Thermaltake H550 TG ARGB Middle tower

## •Specification

Model	H550 TG ARGB
P/N	CA-1P4-00M1WN-00
Case Type	Middle tower
Chassis Dimension (H*W*D)	441 x 225 x 472 mm (17.36 x 8.85 x 18.58 inch)
Net Weight(Case)	7.65 kg / 16.87 lb
Side Panel	4mm Tempered Glass x1
Color	Exterior & Interior : Black
Material	SPCC
Cooling System	<b>Rear (exhaust) :</b> 1 x 120 x 120 x 25mm Addressable RGB fan (1000rpm, 27.2 dBA)
Drive Bays -Accessible -Hidden	2 x 3.5" or 2.5" (HDD Rack); 2 x 2.5" (HDD Bracket)
Expansion Slots	7 + 2
Motherboards	6.7" x 6.7" (Mini ITX), 9.6" x 9.6" (Micro ATX), 12" x 9.6" (ATX)
I/O Port	USB 3.0 x 1, USB 2.0 x 2, HD Audio x 1, RGB Switch x 1
PSU	Standard PS2 PSU ( <b>optional</b> )
Fan Support	<b>Front:</b> 3 x 120mm, 2 x 140mm <b>Top:</b> 2 x 120mm, 2 x 140mm <b>Rear:</b> 1 x 120mm, 1 x 140mm
Radiator Support	<b>Front:</b> 1 x 280mm, 1 x 360mm <b>Top:</b> 1 x 240mm <b>Rear:</b> 1 x 120mm
Clearance	CPU cooler height limitation: <b>165mm</b> PSU length limitation: <b>160mm(With HDD Rack)</b> <b>200mm(Without HDD Rack)</b> VGA length limitation: <b>300mm</b> VGA width limitation(Vertically): <b>45mm</b> RAM height limitation: <b>40mm(With radiator series)</b>

# Thermaltake H550 TG ARGB Middle tower

## •Packaging



Package Information	H550 TG ARGB
EAN Code	4713227522915
UPC Code	841163072929
N.W	7.65 kg / 16.87 lb
G.W	9.15 kg / 20.17 lb
Carton Size (L x W x H)	537 x 304 x 519mm / 21.1 x 11.97 x 20.4 inch
Cuft	3.57
Container	W/O pallet
20'	224
40'	660
40' HQ	770

# Thermaltake H550 TG ARGB Middle tower

Appearance - CA-1P4-00M1WN-00



Angle view



Left Side view

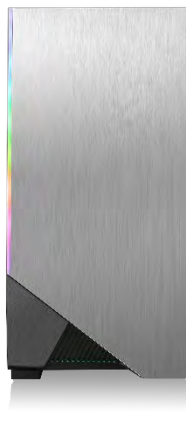

Front view



Right Side view



Internal Structure



Rear view

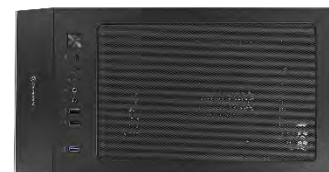

Top view



Bottom view

# Thermaltake H550 TG ARGB Middle tower

- HDD expansion introduction



HDD Bracket

# Thermaltake H550 TG ARGB Middle tower

- HDD expansion introduction



Application

# Thermaltake H550 TG ARGB Middle tower

## •RGB Switch Mode



External RGB switch

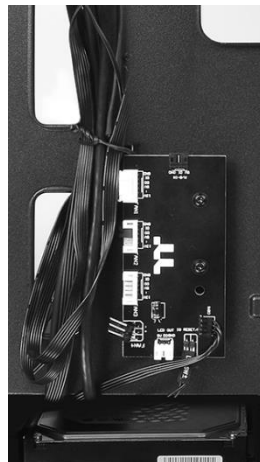

Built-in ARGB controller board

# Thermaltake H550 TG ARGB Middle tower

## •RGB Switch Mode

### I/O Port

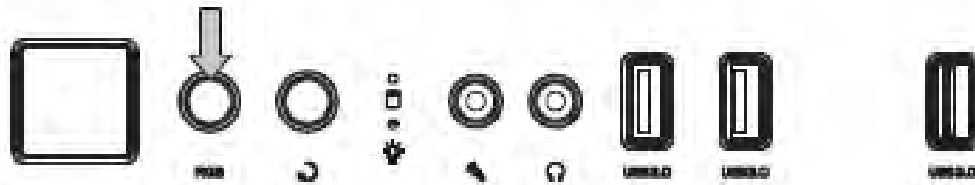

- Wave Mode Mode 1
- Flow Mode Mode 2
- RGB Lighting Mode 3 (Single Color)
- Radar Mode Mode 4-10  
(Red, Yellow, Green, Cyan, Blue, White, Purple)
- Breath Mode Mode 11-18  
(RGB, Red, Yellow, Green, Cyan, Blue, White, Purple)
- Full Lighted Mode Mode 19
- Single Color Mode 20-26  
(Red, Yellow, Green, Cyan, Blue, White, Purple)
- Light Off Mode 27

※ Long press on RGB button for 3 seconds, fan will blink twice which now are controlled by MB software. And vice versa.

### How to connect MB

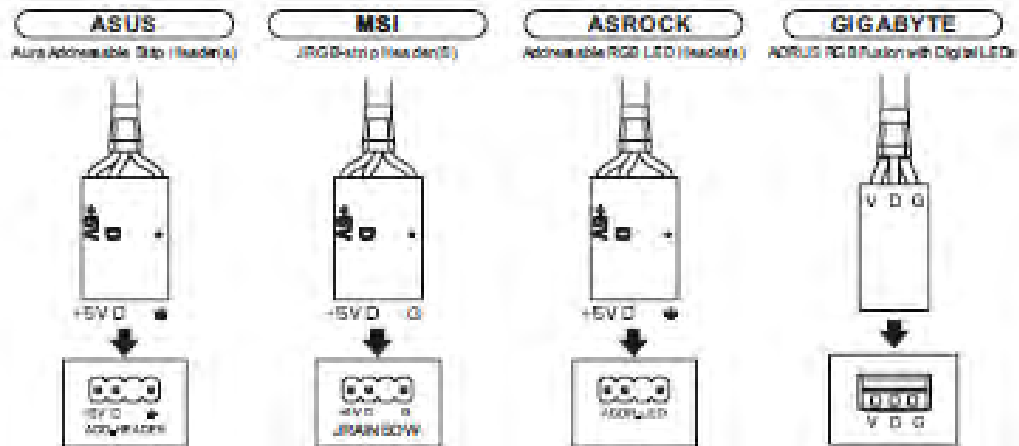



- MB RGB header

## Sync with Motherboard RGB Software

Designed to synchronize with ASUS Aura Sync, GIGABYTE RGB Fusion, MSI Mystic Light Sync and AsRock Polychrome. It supports motherboards that have a 5V addressable RGB header, allowing you to control the lights directly from the above-mentioned software without installing any extra lighting software or controllers. For more details, please visit ASUS, GIGABYTE, MSI and AsRock official websites.



Aura Addressable Header

ASUS



Digital Pin Header

GIGABYTE



JRAINBOW Header

MSI



Addressable RGB LED Header

ASRock

**\*Caution: the motherboard signal connector only supports 5V header.**

# Thermaltake H550 TG ARGB Middle tower

- The Cooling System – AIO Liquid Cooling (Optional)



## **A** CPU Air Cooling System

① Rear (exhaust) : 120 x 120 x 25 mm ARGB fan x 1 (1000rpm, 16dBA)

## **B** HDD Air Cooling System

① Front (intake) : 200 x 200 x 30 mm ARGB fan x 2 (800rpm, 29.2 dBA)

# Thermaltake H550 TG ARGB Middle tower

## • Fan compatibility

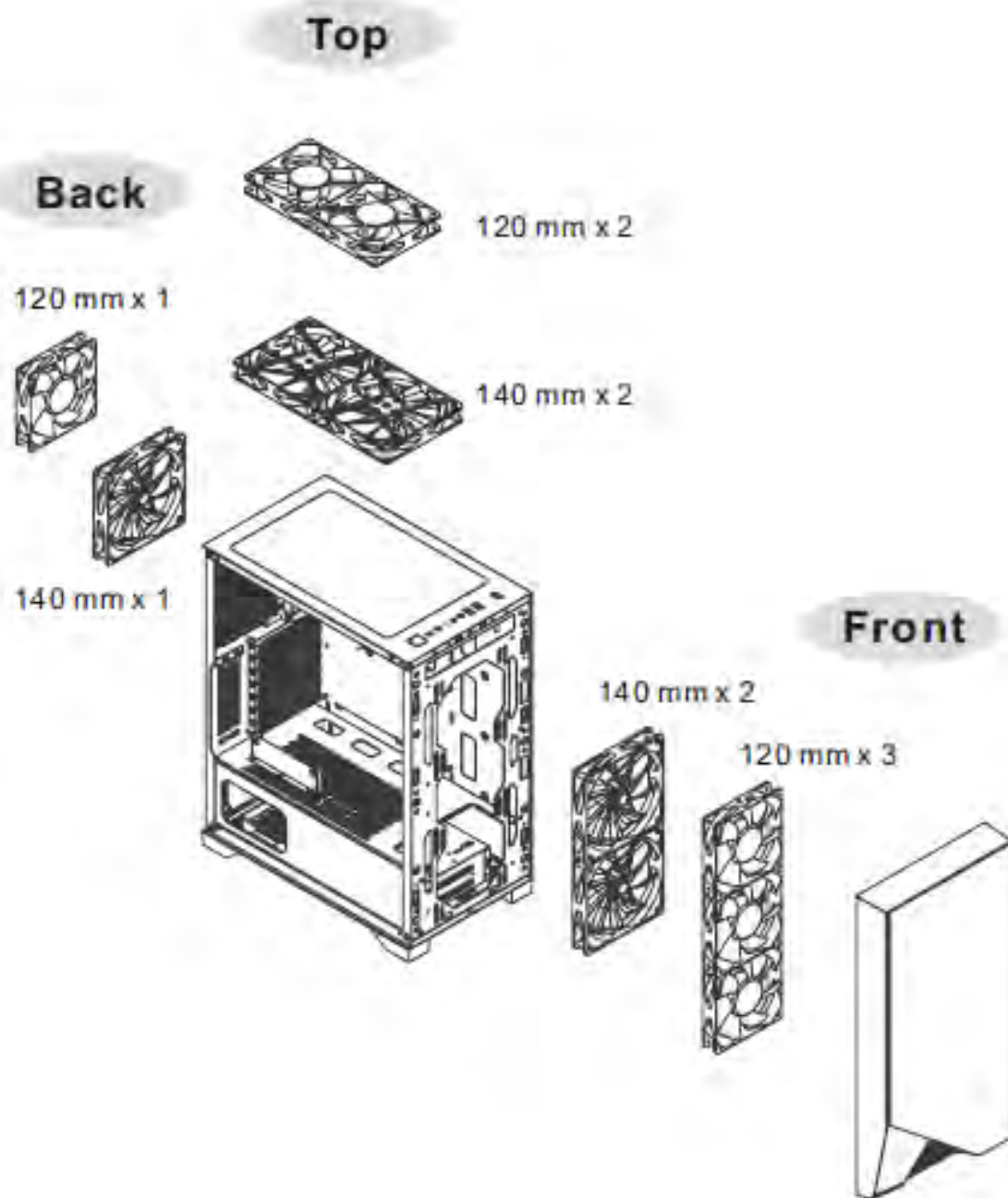

## • Radiator compatibility

※The radiator is applicable up to 40 mm high

**Top**

**Back**

120 mm x 1



240 mm x 1

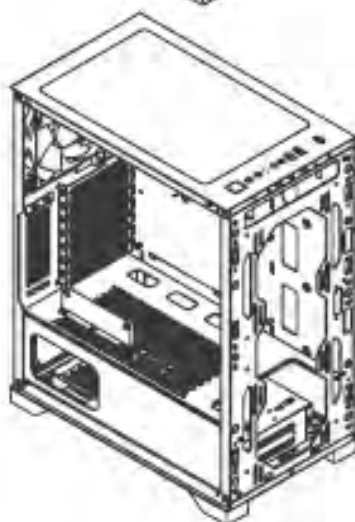
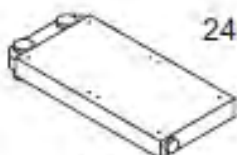

**Front**

360 mm x 1



280 mm x 1



# Thermaltake H550 TG ARGB Middle tower

## • Compatibility List

Fan Compatibility List			
	120mm	140mm	200mm
Front	3	2	-
Top	2	2	-
Rear	1	-	-

Thermaltake Compatible Fan			
	120mm	140mm	200mm
PURE FAN Series	●	●	●
LUNA FAN Series	●	●	●
Riing FAN Series	●	●	●

Radiator Compatibility List						
	120mm	240mm	360mm	140mm	280mm	420mm
Front	●	●	●	●	●	-
Top	●	●	-	-	-	-
Rear	●	-	-	-	-	-

## All-in-One Compatibility List (Water 3.0 and Floe series)

	Performer	Pro	240 Series	360 Series	140 Series	280 Series
Front	●	●	●	●	●	●
Top	●	●	●	-	-	-
Rear	●	●	-	-	-	-